

www
LEVEL
T A R G E T S.hu



FULL OF IDEAS 2014-2015

≡41 Marten

17x39x18 cm



≡7 Owl

22x52x20 cm



≡34 Pheasant

69x15x39 cm



≡37 Falcon

18x48x20 cm



≡26 Turkey

30x66x32 cm



Ivan Mustapic

President HDH-IAA 3D committee
 European Champion 3D
 Multiple Olympic Athlete

"I always practice on LEVEN targets and prefer to shoot them on competitions also."

≡2 Badger

46x66x26 cm



≡22 Crocodile

112x33x28 cm



≡33 Duck

41x28x15 cm



≡39 Carp

68x18x15 cm



≡40 Otter

39x54x25 cm



≡1 Fox

39x54x25 cm



≡32 Goose

59x21x52 cm



≡36 Hare

30x40x22 cm



≡1A Artic Fox

39x54x25 cm



≡5 Rabbit

30x51x22 cm



≡47 Bedded Boar

95x40x30 cm



≡3 Pecari

78x56x27 cm



≡27 Small Piggy

51x30x22 cm



≡6 Wolf

95x58x23 cm



≡44 Chamois

100x61x25 cm





≡11 Deer

109x118x24 cm



≡11A Deer

(dark)
109x118x24 cm



≡46 Leaping Deer

115x100x25 cm



≡13 Bedded Deer

82x45x27 cm



≡13A Bedded Deer

(dark)
82x45x27 cm



≡14 Black Panther

95x58x30 cm



≡38 Turtle

54x100x44 cm



≡42 Wolverine

90x55x25 cm



≡14A Cougar

95x58x30 cm



≡21 Wild Boar

(medium)

95x60x30 cm



≡29 Sitting Wolf

45x85x28 cm



≡8 Wild Boar

123x67x37 cm



Janos Szedlar

World Champion 3D
European Champion

"I have been using ELEVEN Targets when practicing for bowhunting and for 3D competitions as well. ELEVEN have been number 1 choice for almost a decade."

≡35 Tiger

173x89x36cm



≡30 Fallow Deer

125x87x30 cm



≡15 Stag

170x154x42 cm



≡20 Standing Bear

56x192x54 cm



≡45 Elk

200x147x35 cm





≡12 Sheep

103x112x25 cm



≡43 Ibex

110x95x25 cm



Zafer Turkoglu

HDH-IAA Vice President
Bowhunter
CEO ONOK Archery

"Before I go hunting, I always practice
on ELEVEN targets."



≡31 Mountain Goat

125x96x34 cm



≡ F4 Backstop



- 80x80x10 cm
- 80x110x10 cm
- 100x100x10 cm
- 130x130x10 cm
- 80x200x10 cm
- 150x200x10 cm



Camo or Green
Finish

Hyper Cube

6 targets for the price of 2



≡ F5 Multi Target ≡P

40x40x40 cm



100%
≡P

≡HYP Hyper 3D Cube ≡P

51x51x51 cm



100%
≡P

If 10 is the maximum get **≡LEVEN≡**



NEW

≡COWAVE≡

≡conomical & ecological solutions

125x125x20 cm



Kristina Berger

World Champion
woman compound 2013

"≡LEVEN makes everything last longer - my strength, because I don't have to waist it for arrow pulling, - the lifetime of my arrows, because they get stopped smoothly and the target itself last longer than all the others I've ever used!"

As arrow and bow technology is rapidly developing it is now necessary to have a new generation of targets on the archery market.

NEW Eleven has always been a pioneer when it comes to inventions on the target market. The **≡COWAVE≡** name reflects the reduced ecological footprint we leave since 80% of the weight is recycled material. The **≡CO** also reflects that this product is economically correct for the customer, since it is cheaper than any other solution with highest quality level. A cheaper product with higher quality is a good combination making **≡COWAVE≡** unbeatable.

\$ We have put all available knowledge and required material in this product to achieve:

- arrow stop at any weather condition, at any poundage, any arrow
- unbeatable durability with **≡ASY PULL** inserts
- arrow saving technology (longer arrow life)
- easy pulling for the archer with **≡ASY PULL** inserts
- modular solution to make target handling easier
- any target type or variation can be built and adopted to your needs

+ To achieve all the required features above a high density shred of recycled material is used. High density means heavier targets. **≡COWAVE≡** is heavier than our previous targets of the same size. This is one of the reasons why we use the modular system. The other one is the high grade of flexibility it gives our customers to have the target customized to their needs at different events or different stages of one event.

C+C

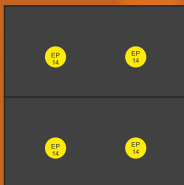

B+C

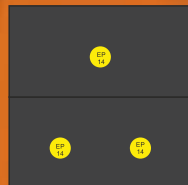

B+B



D+D+D+D



K+L+K

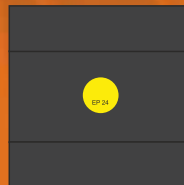

K+M+K

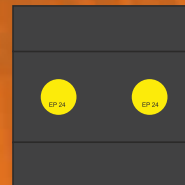

M+M



K+N+K

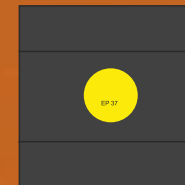

K+O+K



P+P+P+P



≡P Stick Lock

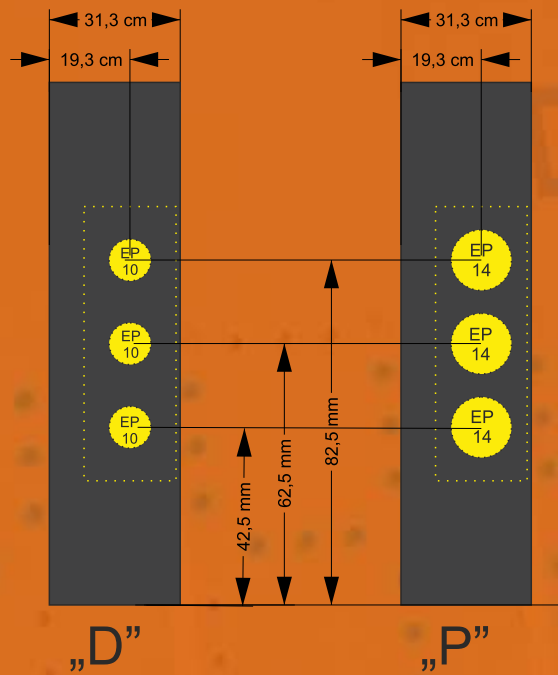
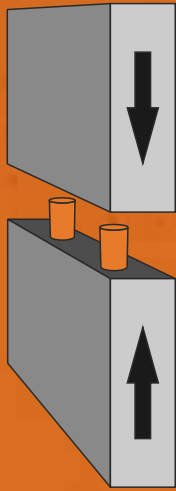

„A”

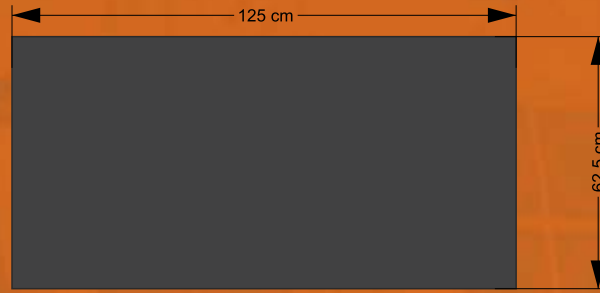

„B”

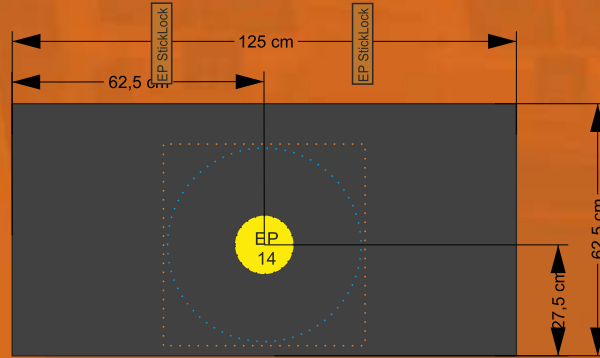

„C”

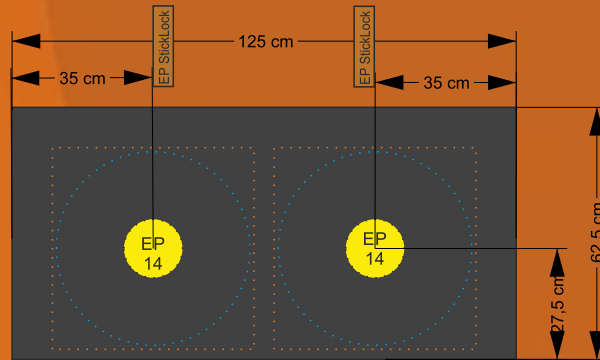

„N”

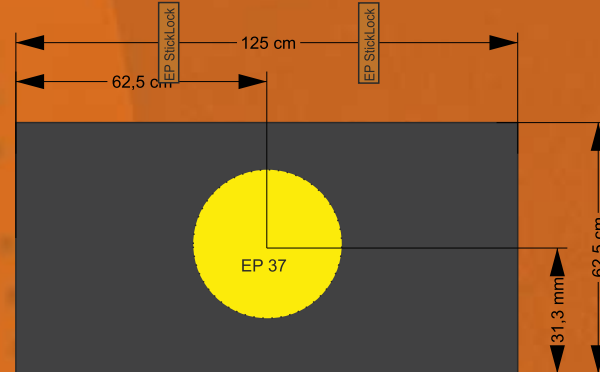

„K”

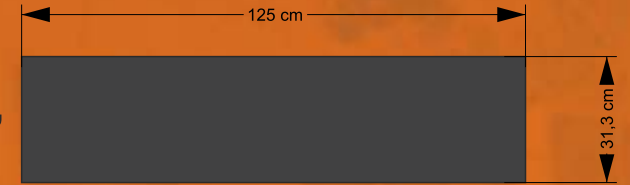

„L”

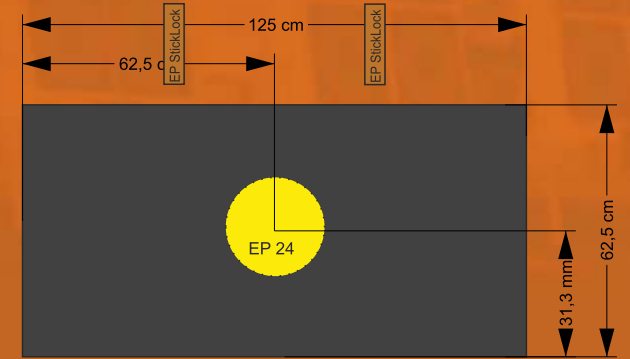

„M”

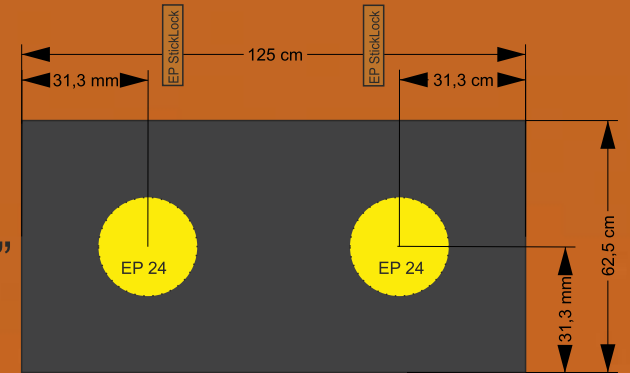

„O”

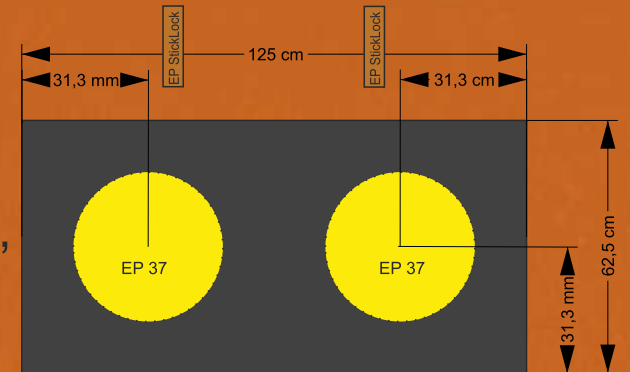

NEW **EPRO**

EPRO
The Spartan of ECOWAVE

- EPRO-60**
60x60x7 cm
- EPRO-80**
80x80x7 cm

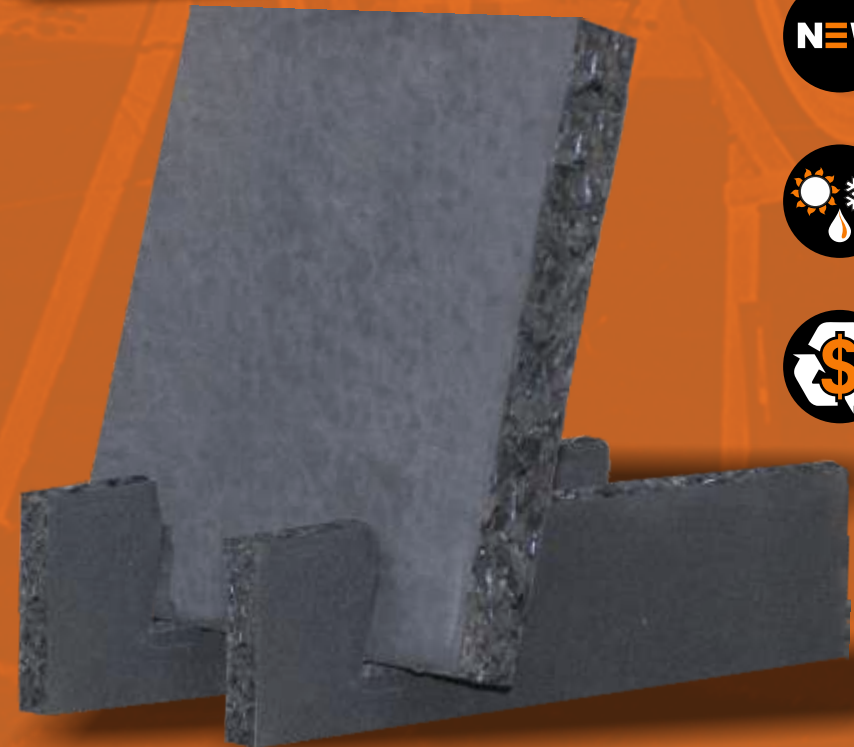
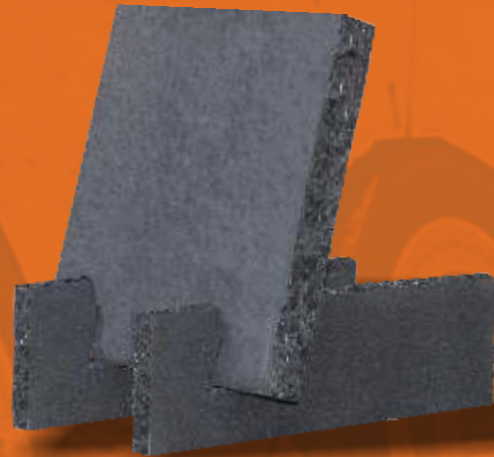

Ivana Buden

Target Championships 2nd place 2013
 Pro Archery Series 1st place 2013
 Field Championships 1st place 2012

„I have very high expectations of the target I'm using for both my every day training and competition. A good target will safety stop every arrow, indoor or outdoor. It will be soft enough to reduce any possible damage to the arrow. It will reduce shoulder injuries caused by hard targets which make it hard to pull the arrows out. And an amazing target will do ALL of the above. And This is why I use ELEVEN targets and would recommend them to all the archers, professional or recreational.”

NEW

☀️ ❄️

🔄 \$

THE WALL

No more arrow lost. This netting stops arrows, at any pundage.*



Hang it up



WA-1 Grey Finish



Interlockable

Hook the nets to eachother!



WA-2 Green Finish

We deliver the ordered length (in meters), but one wall is 25 meters long.

*except for Easton x10 and CarbonExpress Nano

STARTER SETS

Not only for beginners

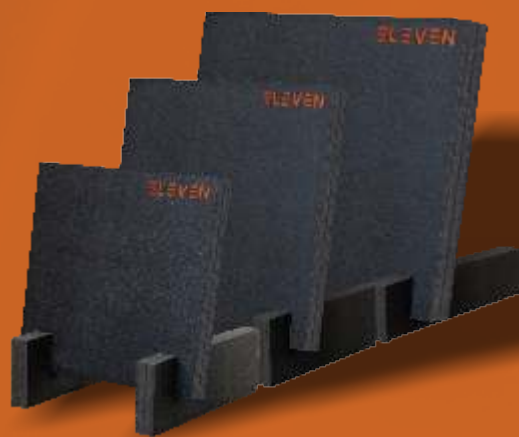

60x60x7 cm
 80x80x7 cm
 100x100x7 cm

F3 Target EP

44x44x22



100%
EP



Arpad Banda

CEC 1st place - 2013
 Target European Cup 2nd place - 2013

„I spend a lot of time on shooting,
 therefore I don't have much time over for
 changing targets and arrow-pulling.“

PUZZLE

The supreme Solution
 Transportation is a breeze with this target.
 Taken apart it fits in the back of your car.
 It's design and light material make it
 to the perfect mobile outdoor target.



100%
EP

PPTF

For thousands of shots @ all weather conditions

Permanent
Practice
Target
Face



Changable Parts

PPTFC

Complete Set



PPTFR Red+Yellow Circle



PPTFY

Yellow Circle

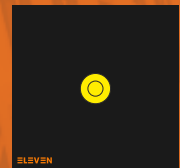

Face 2 Face junior 2nd place - 2009
Junior Cup in Italy 4th place - 2010
Junior Cup in Cyprus team 4th place - 2011

„I speak now positively about your products
because I already love them and they work perfectly!”

Peter Alexander Sigil

Order PPTF with your own logo
(max. 10 characters)



EP Insert variations

Anyway you want them



Polyfoam Targets

45-60-80-90-100-125 cm

- 22cm to 60# (for compound bow)
- 25cm to 50# (for recurve bow)
- 15cm to 50# (for recurve bow)

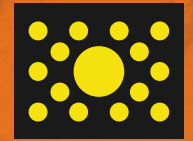

F2 EP Inserts

Ø 9.5 - 14.5 - 24.5 - 37.5 - 50 cm

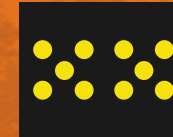

Order Polyfoam targets with your own logo
 (max. 10 characters)





EVEN STAFF

KEY



New Products



ECO solutions



According to most 3D rules



Targets made out of
100% EasyPull Material



Easy Pull Material insert
can be ordered separately



3D targets
with removable EP inserts



Puzzle or modular solutions



All Weather solutions



All ELEVEN targets are made in the EU, Hungary
ELEVEN Archery Targets



www.eleventargets.hu
eleven3d@t-online.hu

Some product may differ from the images displayed in the catalogue.
ELEVEN hold the rights to change, alter or remove products from production